

Installation Guide

Omada Bullet PoE Security Camera

*Images may differ from actual products.
Omada BMP Bullet is used for demonstration in this guide.
©2026 TP-Link 7100002952 REV1.0.0

 **Set up with videos:**
Scan the QR code or visit <https://support.omadanetworks.com/video/?category=omada-security-camera> to search for the setup video of your product.



More Resources

Main Site	https://www.omadanetworks.com/
Video Center	https://support.omadanetworks.com/video/
Documents	https://support.omadanetworks.com/document/
Product Support	https://support.omadanetworks.com/product/
Technical Support	https://support.omadanetworks.com/contact-support/

Warranty

For details on the warranty period, policy, and procedures, visit <https://support.omadanetworks.com/warranty-services/>.

Support

For technical support, user guides, and other information, please visit <https://support.omadanetworks.com/>, or simply scan the QR code.



1. Get Ready

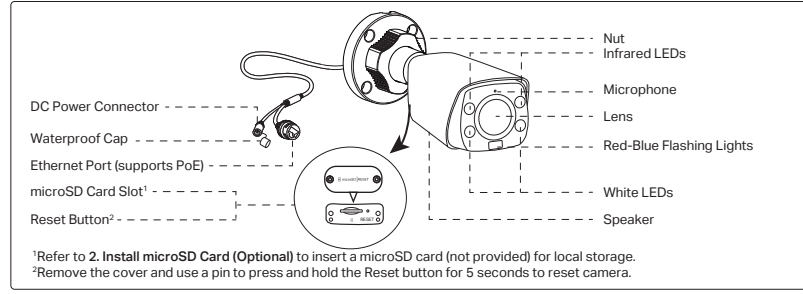
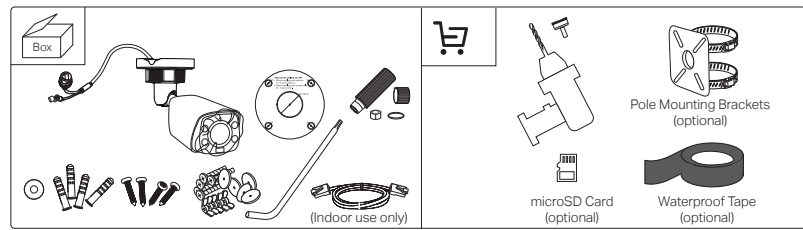

2. Install microSD Card (Optional)

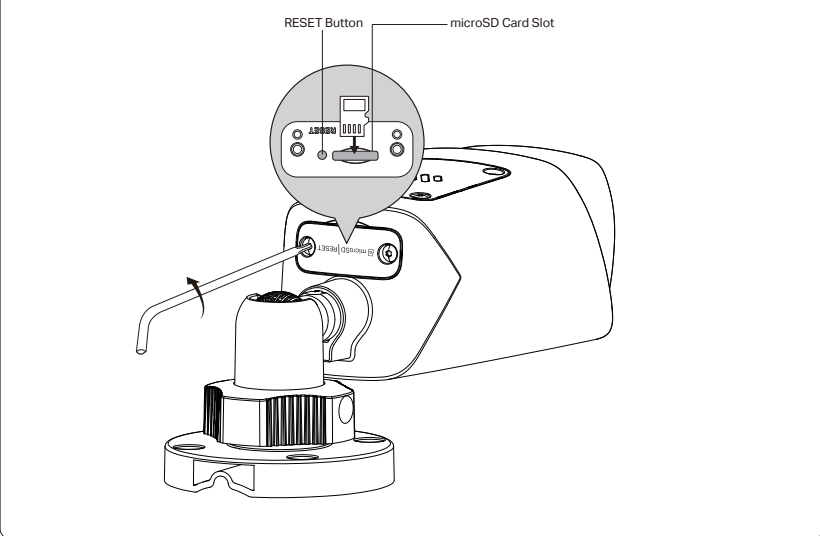

3. Set Up Camera

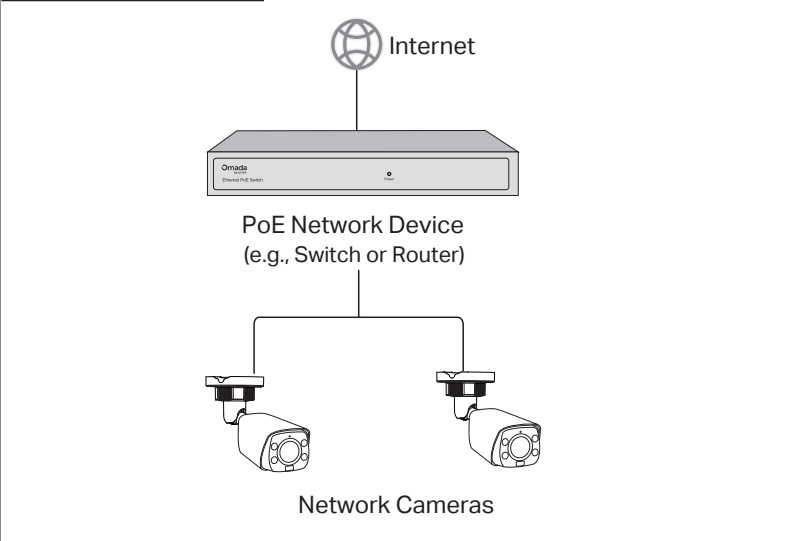

Step 1. Connect the hardware

Connect your camera to the network.

Step 2. Power on the camera

Power on the camera with the PoE power supply or an external power adapter (not provided).

Step 3. Set up the camera

Download and launch the **Omada Guard app**, and follow the on-screen instructions to finish initial setup.



* You can also connect the camera to an NVR and use the NVR to set up and manage the camera. For more detailed instructions, refer to the user guides at <https://support.omadanetworks.com/>.

4. More Management Methods

Method 1: Via an Omada NVR

The camera works with an NVR for easier batch access and management. Here, we use an Omada NVR as an example.

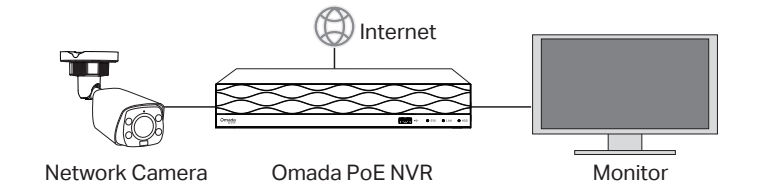

1. Make sure your NVR is working properly and connected to the internet.
2. Connect the camera to the PoE port of the NVR.
3. Follow the on-screen instructions to activate and add the camera.

Method 2: Via a Web Browser

1. Find the camera's IP address on your router's client page.
 2. On your local computer, open a web browser and enter <https://> followed by your camera's IP address (<https://192.168.0.60> by default).
 3. Follow the web instructions to activate your cameras.
- Done. You can view the live video on the Live View page and go to the Settings page to change camera settings.

5. Mount Camera

Option 1

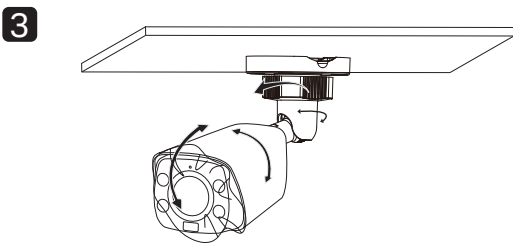
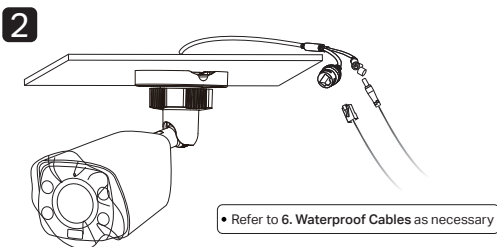
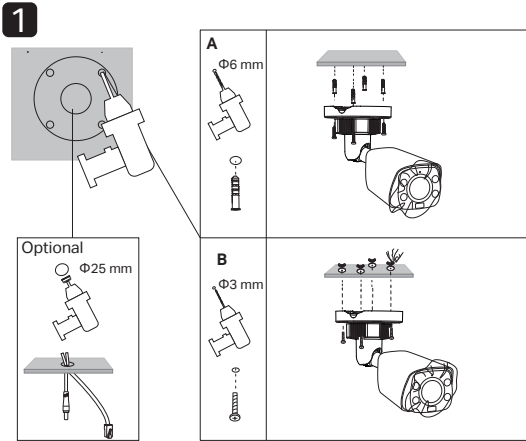
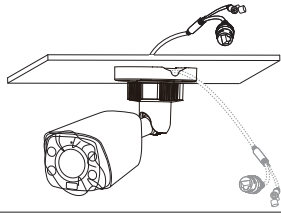

Option 2

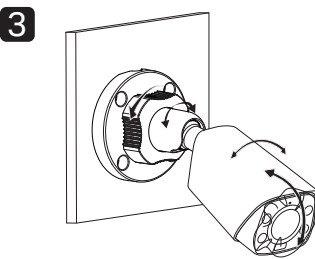
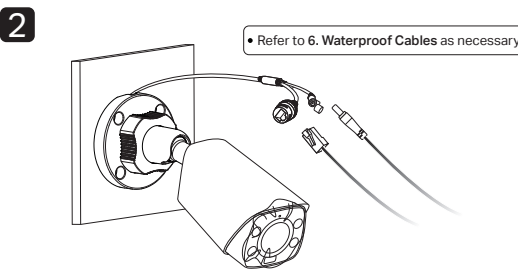
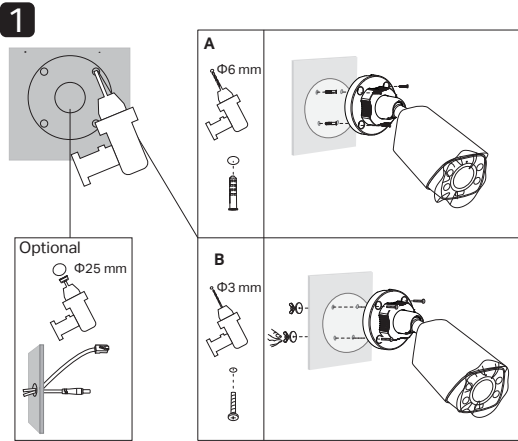
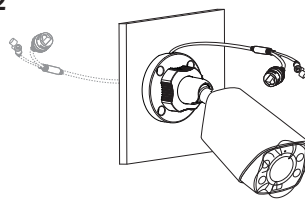

Option 3

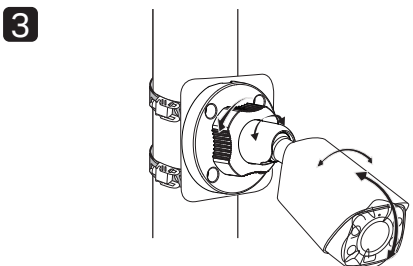
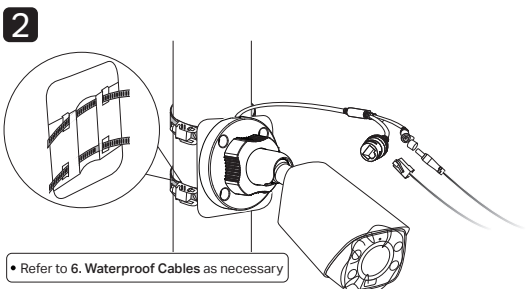
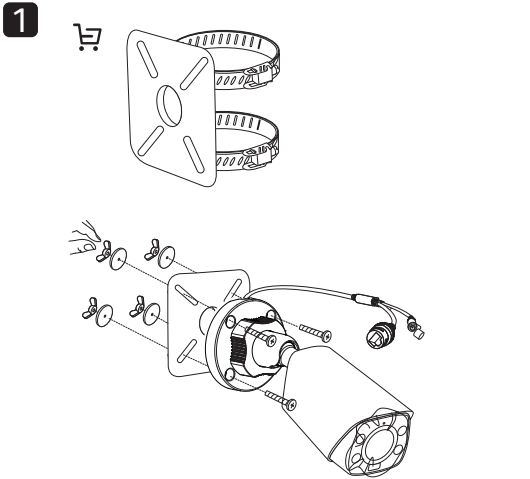
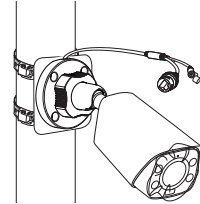

Tighten Bracket Nut

! Tighten the bracket nut after adjusting the camera angle.

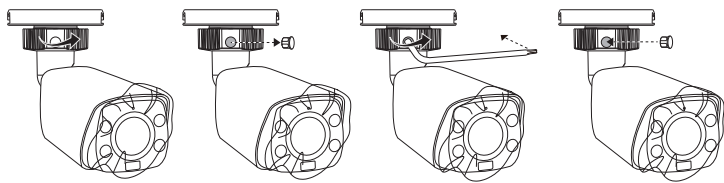

Remove Protective Film

! Keep the protective film during installation and remove it before use.

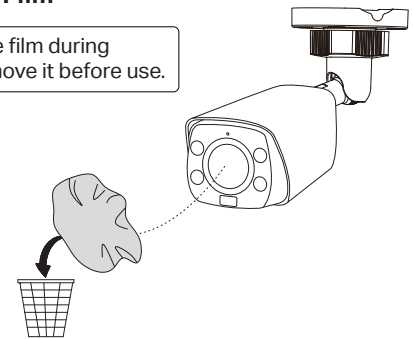

6. Waterproof Cables (Optional)

For Ethernet Cable

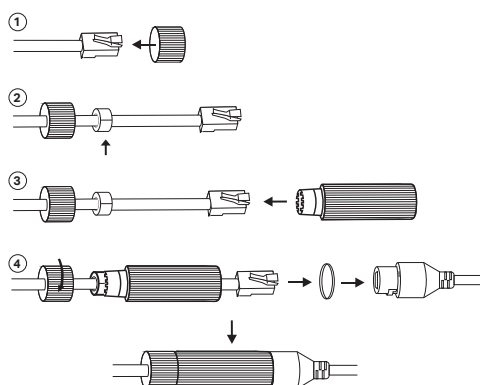

For Power Cord

■ Powered by PoE

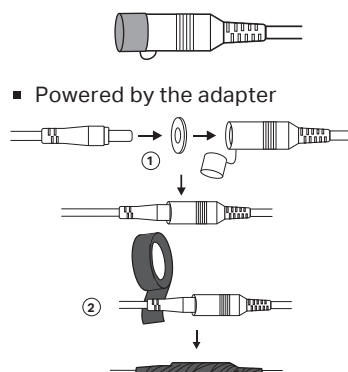

■ Powered by the adapter

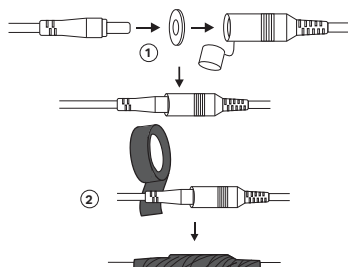

Safety Information

- Make sure your power supply matches your camera. The power source should comply with Power Source Class 2 (PS2) or Limited Power Source (LPS) of IEC 62368-1.
- Make sure that the wall is strong enough to withstand 4 times the weight of the camera and mounting bracket.
- If you are uncertain or uncomfortable performing the installation, consult a qualified electrician. It is recommended to install it in a place that children cannot touch.
- Do not use any other power adapters than those recommended.
- Do not use damaged power adapter to charge the device.
- Do not attempt to disassemble, repair, or modify the device. If you need service, please contact us.
- Adapter shall be installed near the equipment and shall be easily accessible.
- Keep the device away from fire or hot environments. DO NOT immerse in water or any other liquid.
- Use only power supplies listed in the user instructions. Refer to the User Manual on the product support page.
- Recommended Adapter should be used indoors where the ambient temperature is lower than or equal to 40 °C.

EU Declaration of Conformity

TP-Link hereby declares that the camera is in compliance with the essential requirements and other relevant provisions of directives 2014/30/EU, 2014/35/EU, 2009/125/EC, 2011/65/EU and (EU)2015/863.

The original EU Declaration of Conformity may be found at <https://www.tp-link.com/en/support/ce/>

UK Declaration of Conformity

TP-Link hereby declares that the camera is in compliance with the essential requirements and other relevant provisions of the Electromagnetic Compatibility Regulations 2016 and Electrical Equipment (Safety) Regulations 2016.

The original UK Declaration of Conformity may be found at <https://www.tp-link.com/support/ukca/>